

VAC digital 1.6



TECHNICAL CHARACTERISTICS

Power (W)	1600
Air-flow (m ³ /h)	190
Waterlift (mm/H ₂ O)	3100
Airwatts	591
HEPA filter surface area (cm ²)	6000
HEPA filter surface area (cm ²)	1300
Bin Capacity (L)	20
Noise level (dB)	≤60
Weight (kg)	15

High speed By-Pass peripheral motor

RECOMMENDATIONS FOR INSTALLATION

Dwelling size in m ²	≤350
Furthest valve from the unit (lm)	30
Maximum number of inlet valves	8

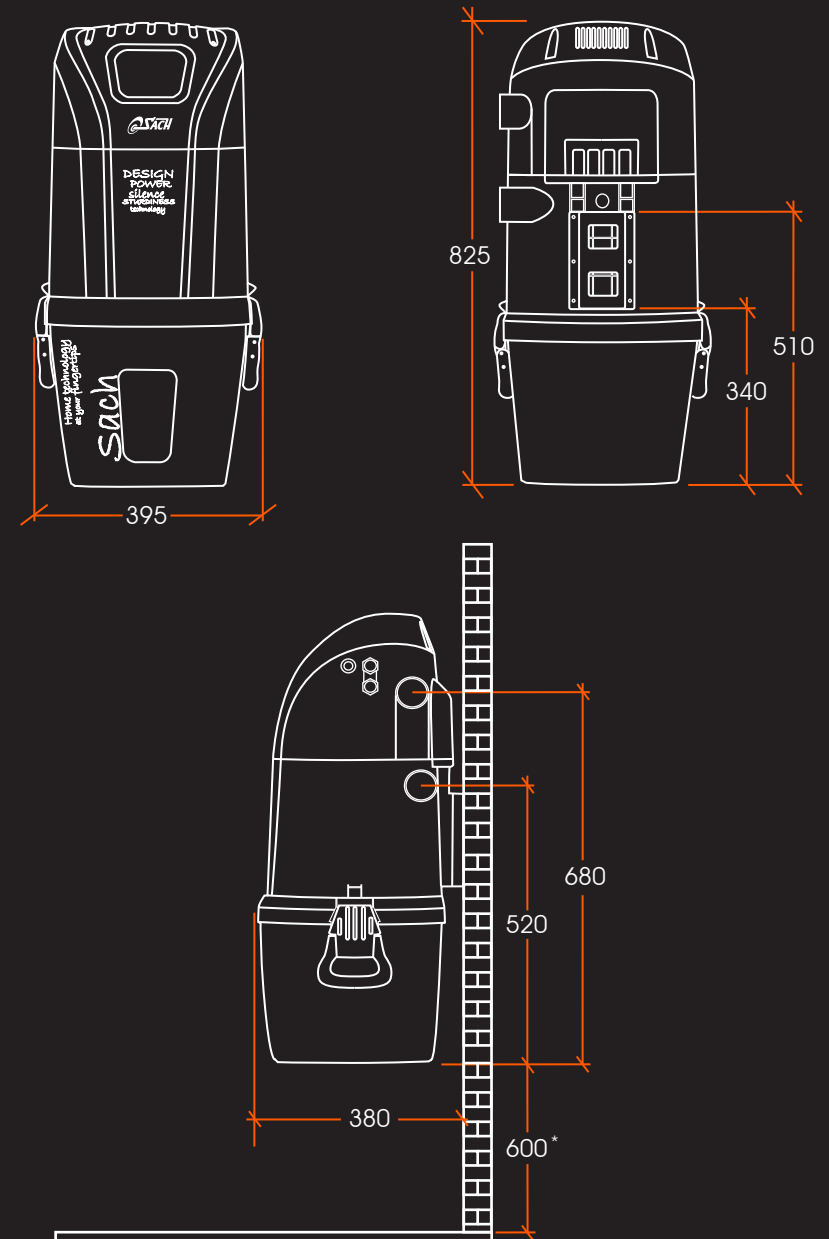

* Minimum space recommended to allow the dust container to be emptied comfortably.